

Facet

by

TURF

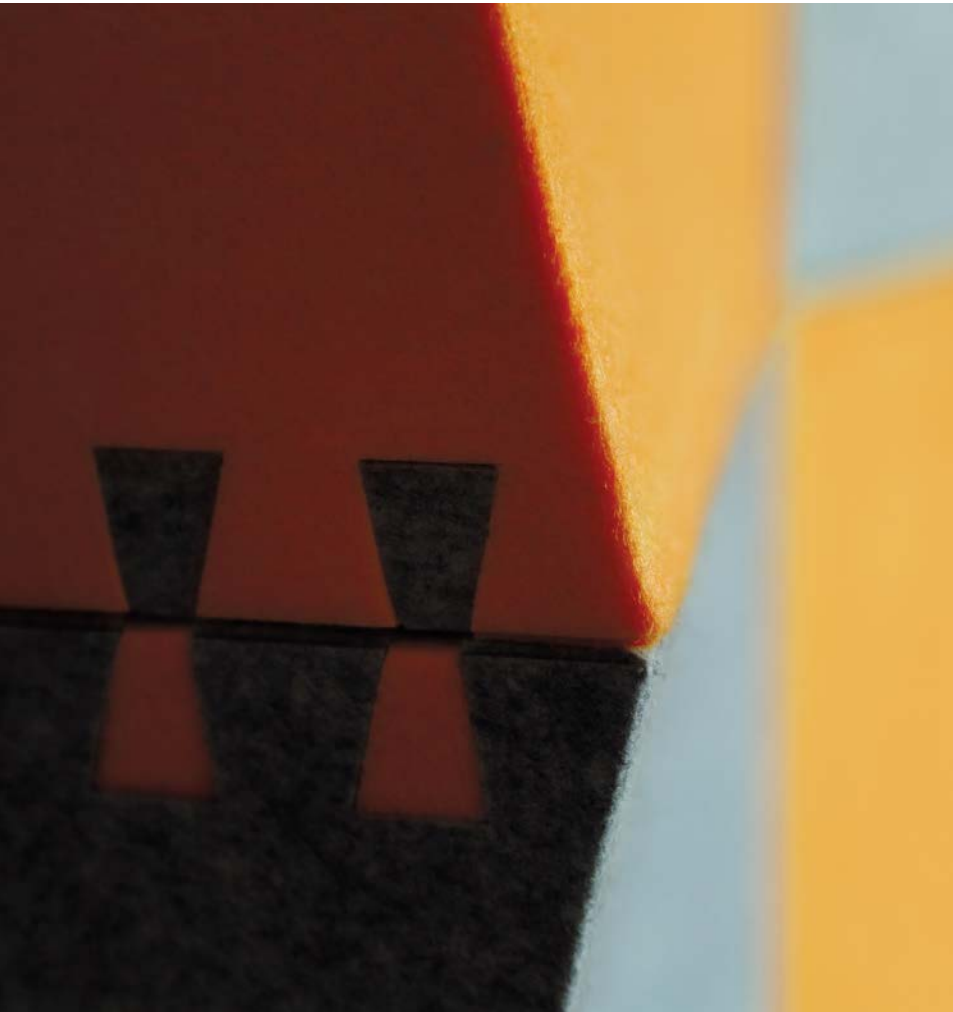

Facet

DYNAMIC & MODULAR

With enough time, geological pressures will split continents, mountains, and cliff faces, resulting in unforgettable landscapes and unique geometric faces. The Facet series is an acoustic wall system that simulates these complex geometries by using three interchangeable tiles that link together in endlessly unique and custom orientations.

Facet is constructed by folding a single piece of felt around an internal 4 sided french cleat frame that allows the end user to endlessly rotate, swap, and alternate the tiles to customize their office space on a whim.

Assembly

SIDE PERSPECTIVE

Facet is a series of three tiles [A, B, C] that are designed with geometries that flow into each other to **create chunky undulations and acoustically absorbent wall sculptures.**

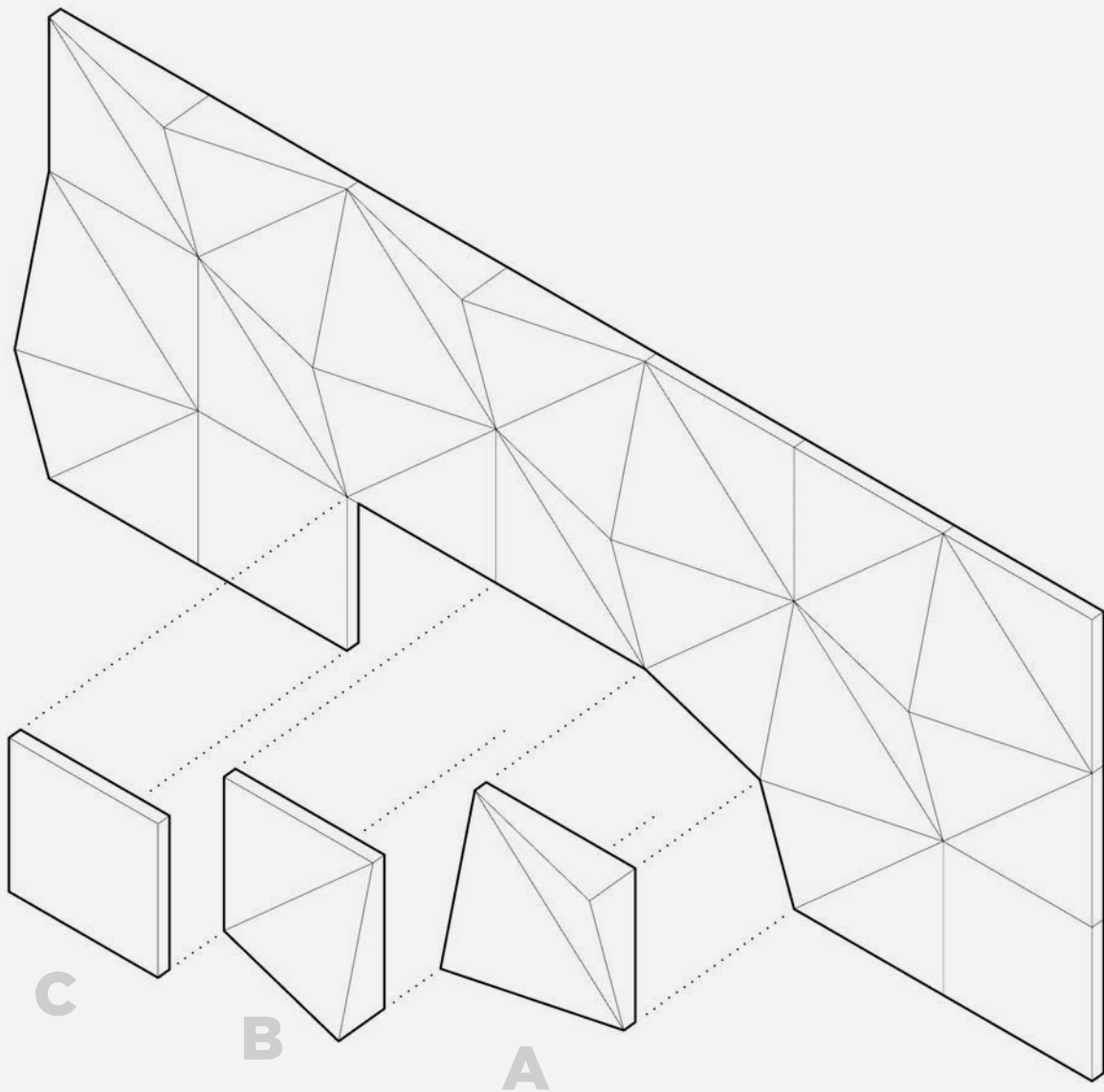

Installation

INSTALLATION PERSPECTIVE

Installing Facet is extremely easy with the included French cleats. Simply mount the receiving French cleat along the wall **horizontally and vertically on 1'-11 7/16" centers**, then hang the Facet tile on any one of four sides of it's internal frame.

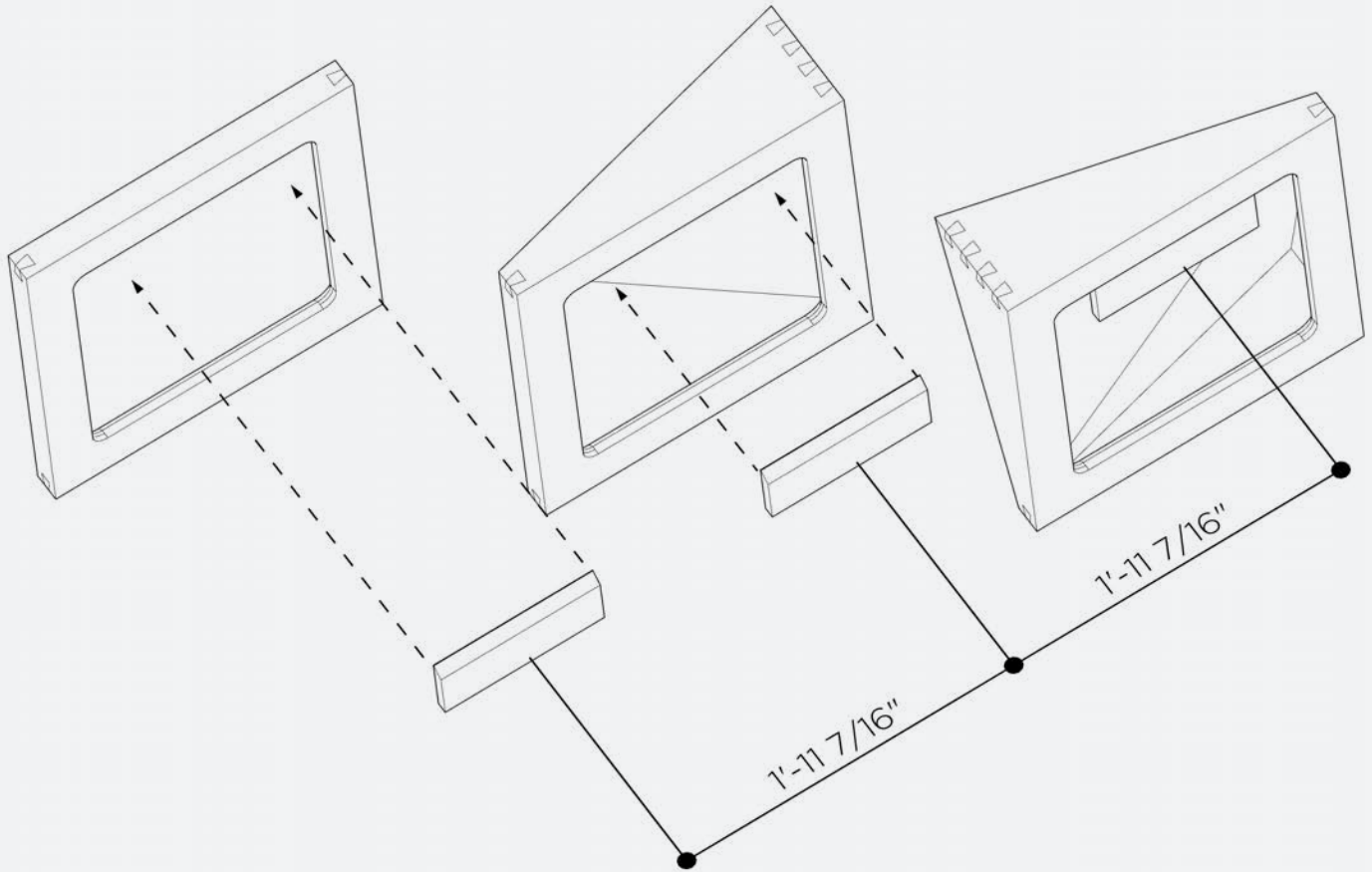

SALVAGED SCRAP

Facet's internal frame and included French cleat is manufactured out of post industrial scrap salvaged from local manufacturers.

Tile A

1

PERSPECTIVE

Tile A is an angle to angle tile that is designed to transition from Tile A to Tile B. With a 7" air gap, the tile is extremely absorbent of echos in interior spaces.

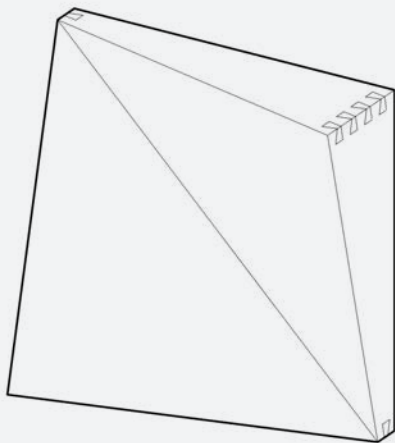

3

SIDE ELEVATION

2

FRONT ELEVATION

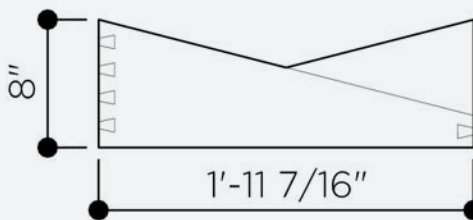
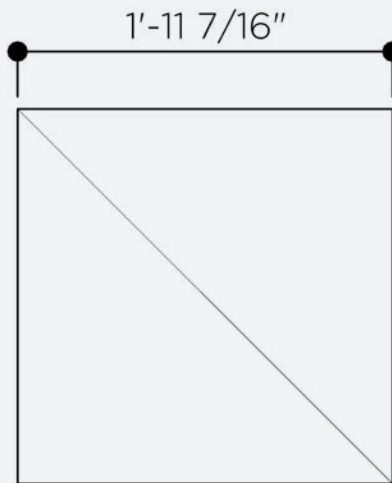

4

TOP ELEVATION

Tile B

1

PERSPECTIVE

Tile B is a flat to angled tile that is designed to transition from Tile A to Tile C. With a variable air gap of 1.5" to 7.5", the tile is extremely absorbent of echos in interior spaces.

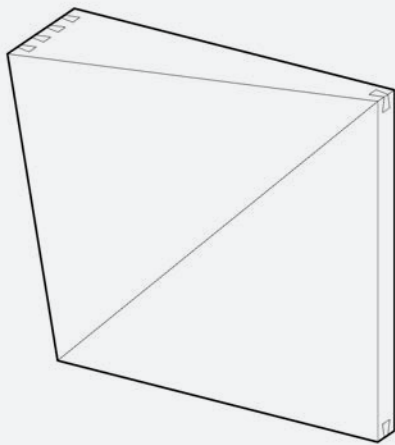

3

SIDE ELEVATION

2

FRONT ELEVATION

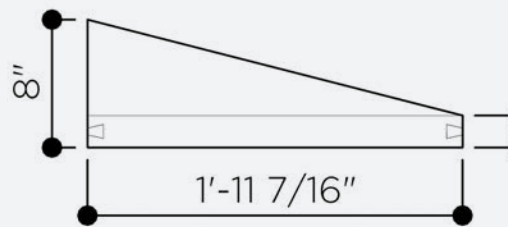
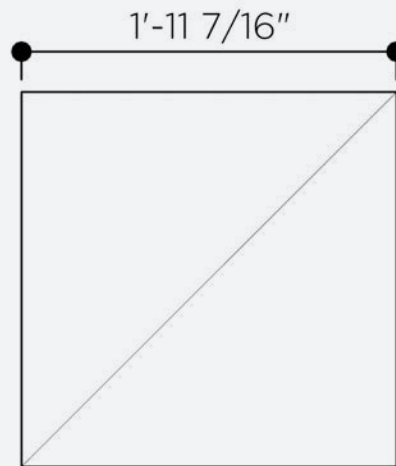

4

TOP ELEVATION

Tile C

1

PERSPECTIVE

Tile C is a flat tile that is designed to transition from Tile B. With a 1.5" air gap, the tile is extremely absorbent of echos in interior spaces.

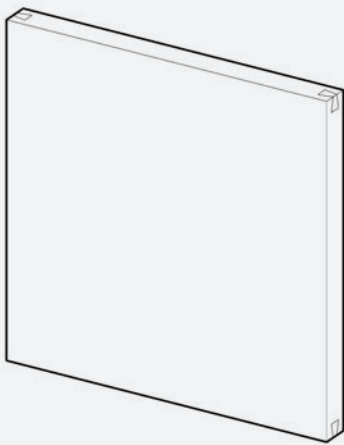

2

FRONT ELEVATION

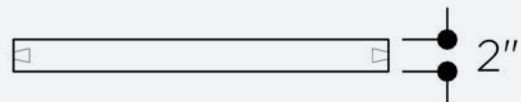
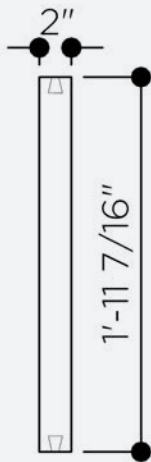
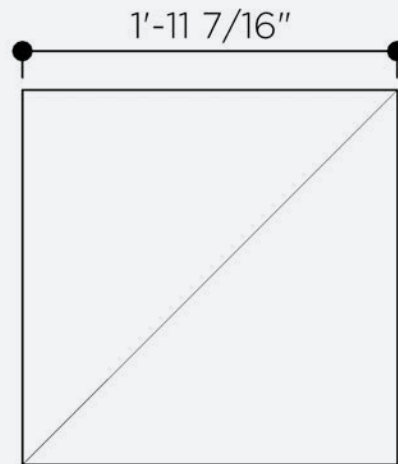

3

SIDE ELEVATION

4

TOP ELEVATION

Specifications

PRODUCT NAME	Facet (patent pending)
CONTENT	99% Recycled Polyester Felt
FELT THICKNESS	9mm
PANEL THICKNESS	1" - 8"
STANDARD SIZE	24" X 24"
MAXIMUM SIZE	24" X 24"
EDGE OPTIONS	Exposed Felt with Dove-tail Felt Connectors
COMPONENTS	French Cleat made from salvaged post industrial wood products
DURABILITY	Contract
MAINTENANCE	Vacuum occasionally to remove any particulate matter and air-borne debris or dust. Compressed air can be used to dust the material in difficult to reach areas or for large assemblies.
LEAD TIME	Shipped in 4 weeks.
ENVIRONMENTAL	9mm PET felt board is made from over 99% recycled polyester plastic, over 50% of which come from recycled water bottles. TURF is pursuing product transparency for LEED V4 MR Credit 4 Option 1, and MR Credit 3 Option 2 for recycled content. TURF is pursuing a Declare Label for this product.
VARIATION	PET Felt uses a traditional 'felting' process to create it's panels. This often results in a pleasing heathered' effect, where multiple tones are present in the fiber. Slight and consistent variations in color should be expected when using this sustainable material.
ACOUSTICS	ASTM C 423: NRC [500hz] = .76 NRC [1000hz] = 1.00
FIRE RATING	UL tested ASTM E-84: Class A

9MM Felt Colors

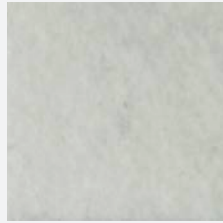

5 WHITE



1 CREAM



4 LIGHT GREY



48 LIGHT BROWN



32 BROWN



38 MATTE GREY

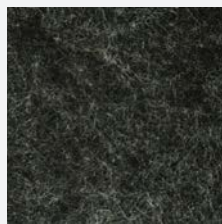

6 CHARCOAL

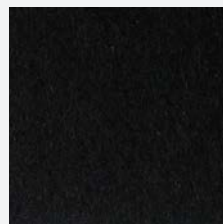

7 BLACK



45 YELLOW



20 MANGO



42 ORANGE



16 RED



39 LAVENDER

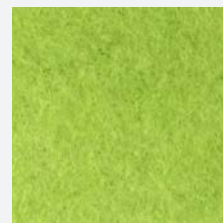

47 LIME



14 GREEN



25 LIGHT BLUE



29 DARK BLUE

Acoustic Testing (ASTM C 423)

FREQUENCY (Hz)	SOUND ABSORPTION COEFFICIENT
32	.03
40	.01
50	-.02
63	-.07
80	.06
100	.09
125	.12
160	.20
200	.24
250	.33
315	.45
400	.59
500	.76
630	.85
800	.89
1,000	1.00
1,250	1.06
1,600	1.06
2,000	.99
2,500	.89
3,150	.83
4,000	.94
5,000	1.04
6,300	1.00
8,000	1.05
10,000	1.07
12,500	1.07

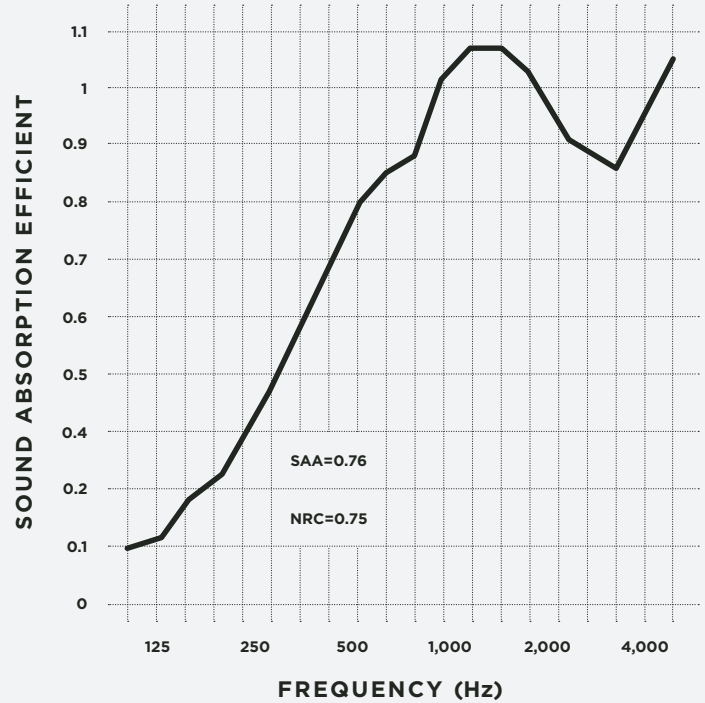

TEST ARRANGEMENT

PET Acoustic panel +100mm air layer (Filled with 50mm rock wool board).